

INTELLIGENT HOTEL
TERMINAL SOLUTIONS

THE HOTEL
INTELLIGENCE SWITCH



NEWGY LOCK LIMITED

E-mail: info@newgylock.com

Tel: 86-755-33078339





Fax: 86-755-33078359

web: www.newgylock.com



Company introduction



- 
High-grade
- 
Energy Saving
- 
Service
- 
Personality

Ultra-thin fashion design, opens the door of fashion

A SERIES LCD DOORPLATE

PRODUCT FEATURES:

- LCD touch screen, with uniform brightness, large area and high-grade.
- Capacitance touch doorbell.
- Micro crystal plate, a variety of colors optional.
- High-grade, Zinc alloy metal edge.
- Personalized hotel logo.
- PC flame retardant insulation bottom box, conform to the international fire standards.
- Standard 86 bottom box installation. Convenient installation.
- Extended fuction: work with various brands of guest control host.



SH-MLA2



SH-MLA3

Size: 86mm×86mm×7mm



SH-MLA3

Ultra-thin fashion design, opens the door of fashion

TECHNICAL PARAMETERS

Working voltage:DC5/12V, AC110/220V;
 Installation environment:86 bottom box.
 Working temperature:-10 - 60 .
 Working humidity:0-95% .
 Service life:relay electric shock morethan
 100000 times

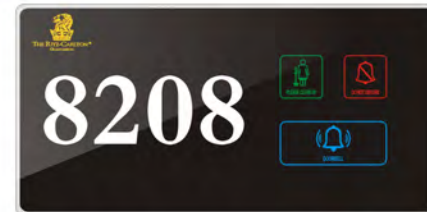

size:86mm×172mm×7mm

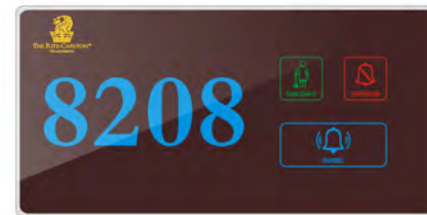

SH-MLB1

Ultra-thin fashion design, opens the door of fashion



SH-MLC3



SH-MLB2

PRODUCT FEATURES:

The most fashionable and durable panels. Adopt micro crystal board is also called the crystal panel as material.

- 1.Preventscratches,preventdiscoloration,prevent deformation.
2. Durable.
3. A variety of optional color panel, more perfect collocation all sorts of decorate a style.



SH-MLC1

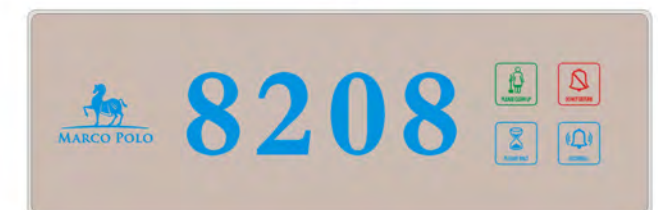

SH-MLC2

size:86mm×258mm×7mm

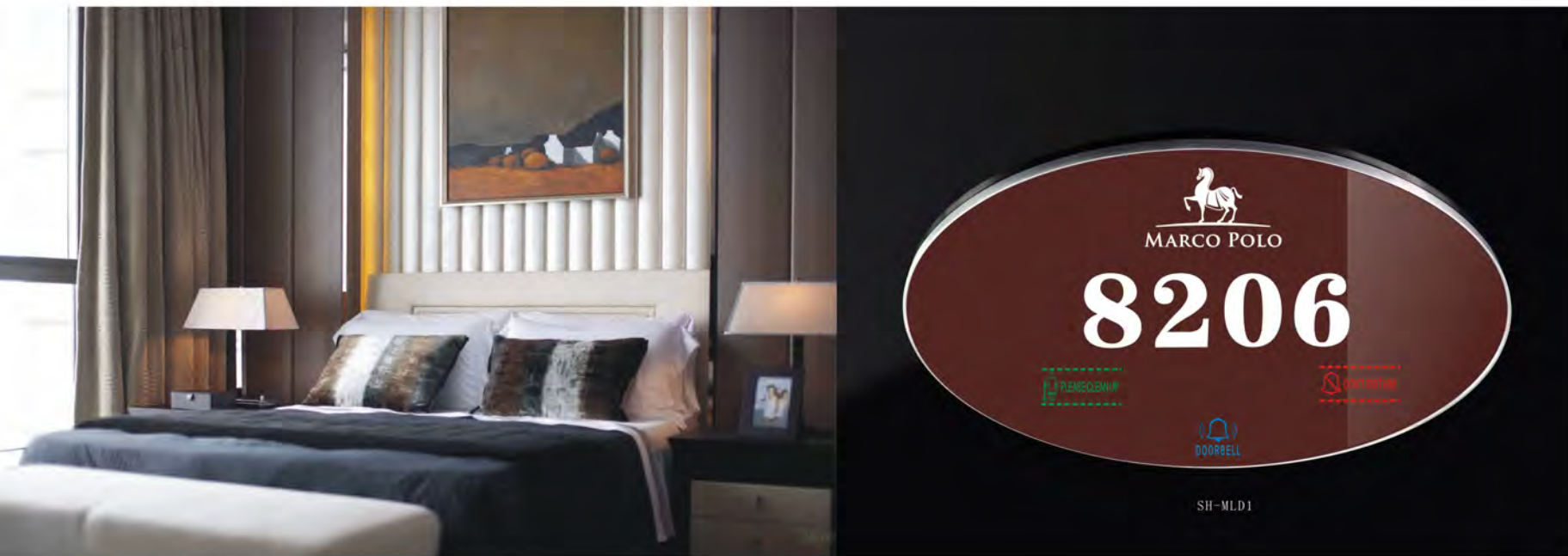

SH-MLD1



size:130mm×230mm×9mm



SH-MLE1

PRODUCT FEATURES:

Ultrathin metal frame, only 9mm thickness.
Equivalent to the thickness of the iPhone 4s.

ULTRA-THIN METAL FRAME



SH-MLD4

SH-MLD3

size:145mm×240mm×9mm

PRODUCT DESCRIPTION

- LCD touch screen, with uniform brightness, large area and high-grade.
- Capacitance touch doorbell.
- Micro crystal plate, a variety of colors optional.
- High-grade, Zinc alloy metal edge.
- Personalized hotel logo.
- PC flame retardant insulation bottom box, conform to the international fire standards.
- Standard 86 bottom box installation. Convenient installation.
- Extended function: work with various brands of guest control host.

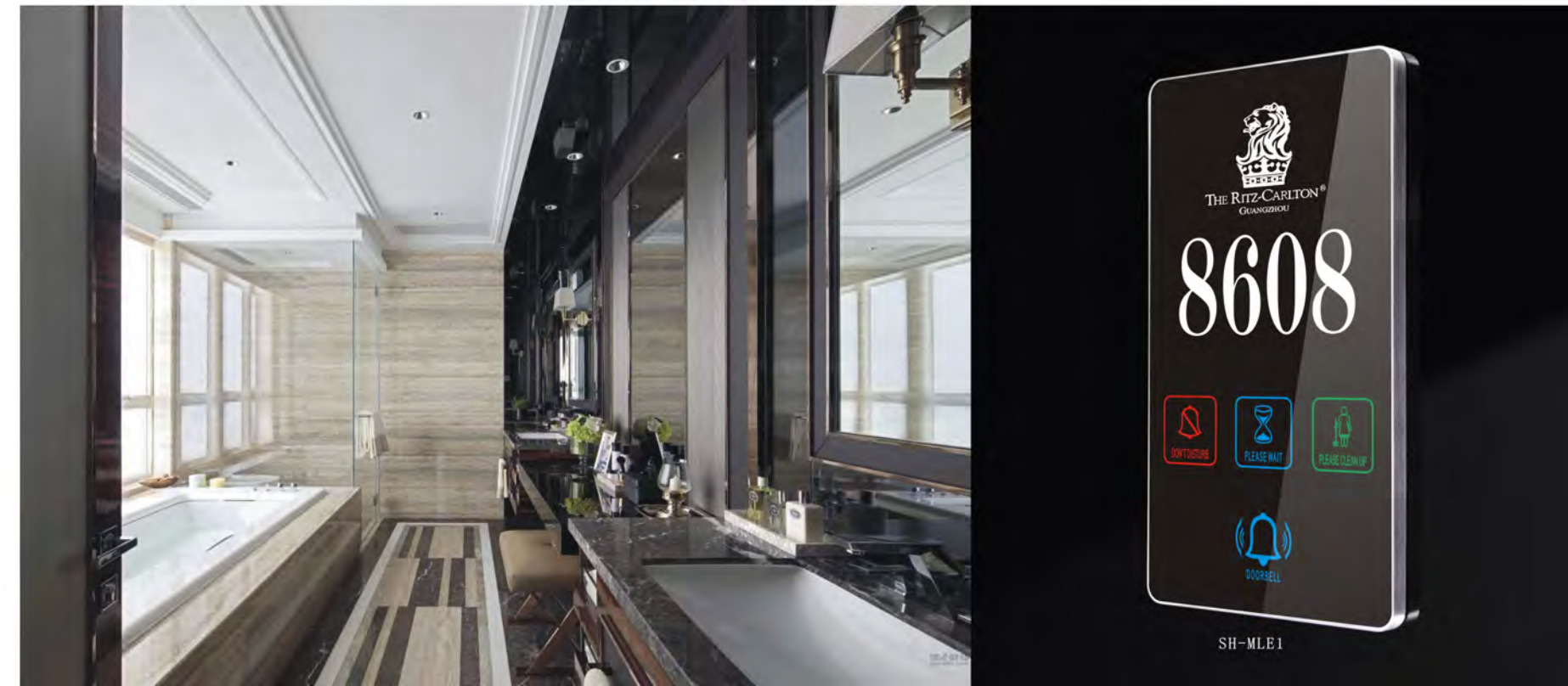

SH-MLE1

Ultra-thin fashion design, opens the door of fashion

PRODUCT FEATURES:

Built-in reinforce insulation film to avoid the installation process for the product damage. Standard fire retardant ABS bottom box, with ABS fire prevention materials, accord with national 3 c certification standards.



size:130mm×230mm×9mm

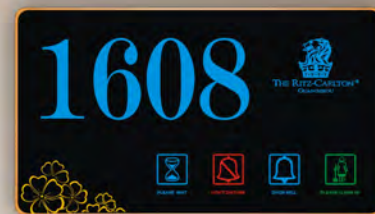

SH-ML E2

Ultra-thin fashion design, opens the door of fashion

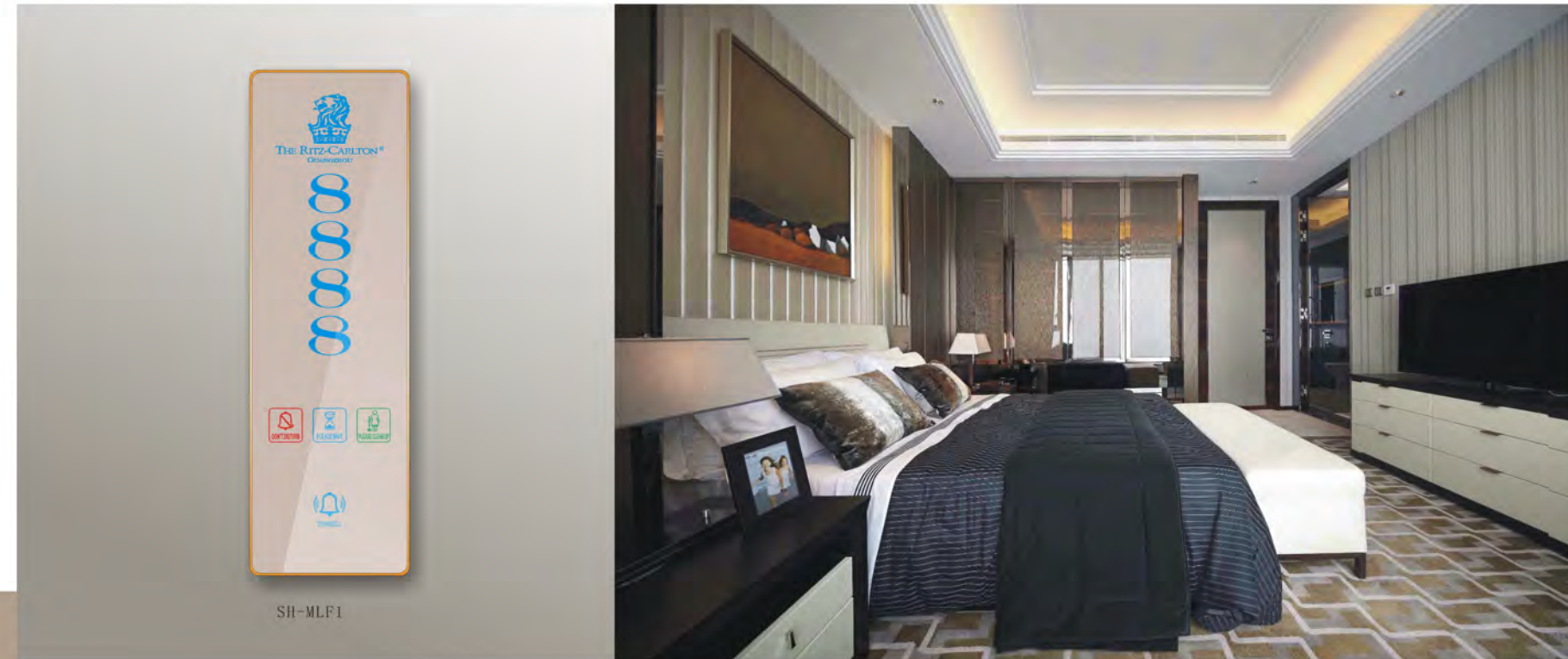

SH-ML F1

PRODUCT FEATURES:

- LCD touch screen, with uniform brightness, large area and high-grade.
- Capacitance touch doorbell.
- Micro crystal plate, a variety of colors optional.
- High-grade, Zinc alloy metal edge.
- Personalized hotel logo.
- PC flame retardant insulation bottom box, conform to the international fire standards.
- Standard 86 bottom box installation. Convenient installation.
- Extended function: work with various brands of guest control host.

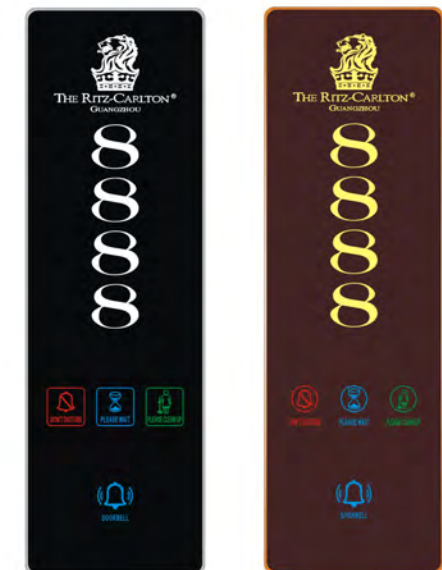

size:120mm×380mm×9mm

Ultra-thin fashion design, opens the door of fashion

PRODUCT FEATURES:

Used in superior hotel,club,sauna,KTV,tea house and so on.Various modern design styles are optional,showing special glamour.The touch light point indication of the LCD backlight is clear which is beneficial to distinguish in night.In one word,it can increase the efficient,convenient and fast service quality of the hotel,and increasethetheguest'ssatisfaction.



SH-MLF2

Size:120mm×380mm×9mm

Ultra-thin fashion design, opens the door of fashion



SH-MLF3



Size:120mm×380mm×9mm

PRODUCT DESCRIPTION:

- LCD touch screen,with uniform brightness,large area and high-grade.
- Capacitance touch doorbell.
- Micro crystal plate, a variety of colors optional.
- High-grade,Zinc alloy metal edge.
- Personalized hotel logo.
- PC flame retardant insulation bottom box, conform to the international fire standards.
- Standard 86 bottom box installation. Convenient installation.
- Extended fuction: work with various brands of guest control host.

PRODUCT DESCRIPTION:

- LCD touch screen,with uniform brightness,large area and high-grade.
- Capacitance touch doorbell.
- Stainless steel panel, a variety of colors optional.
- High-grade,Zinc alloy metal edge.
- Personalized hotel logo.
- PC flame retardant insulation bottom box, conform to the international fire standards.
- Standard 86 bottom box installation. Convenient installation.
- Extended fuction: work with various brands of guest control host.



size:120mm×380mm×9mm
SH-ML12



size:130mm×230mm×9mm
SH-ML11



PRODUCT FEATURES:

- Ring the bell room number "doorbell" key in the switch, door bell let the guest know room have visitors.
- Guests press the "do not disturb" switch inside the room, the "do not disturb" design of LCD back light. Outside the screen display please don't disturb, the doorbell button doesn't work.
- When guest press "please clean up" switch in room, touch screen "please clean up" design back light. Outside the screen tip in the room needs cleaning.
- When the visitor coming and guests is not convenient to open the door for, can press please wait switch. Door screen "please wait" lights, remind visitors wait a moment.
- After the guests into the room and insert the card into energy saver switch, door light glows, tell the waiter someone is in room.
- Room number light up 24 hours.
- LCD liquid crystal display, standard 86 bottom box installation and bottom box of PC flame retardant materials.

DIAGRAMMATIC DRAWING FOR HOTEL GUEST ROOM WIRING

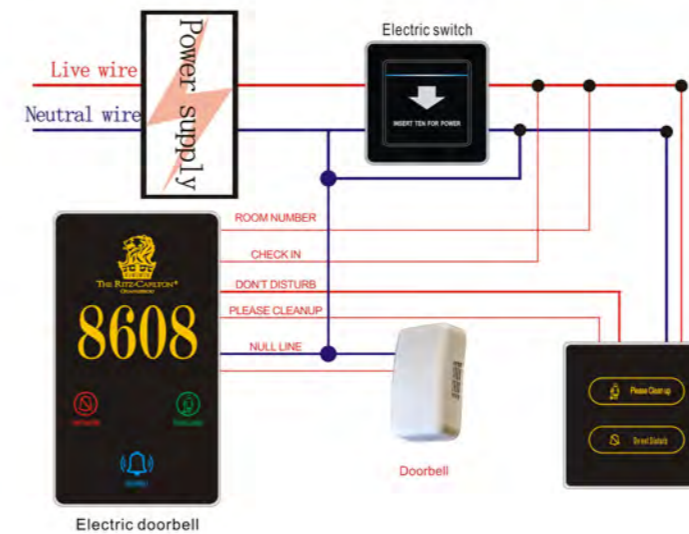

Electronic doorplate function description

	Hotel name and logo
	Micro crystal plate
	LCD hotel room number display
	Please wait function
	Please clean up function
	Don't disturb (clean up, doorbell interlock)
	Ultrathin zinc alloy frame is only 9mm

130mm*230mm

Used in superior hotel,club,sauna,KTV,tea house and so on. Various modern design styles are optional, showing special glamour. The touch light point indication of the LCD backlight is clear which is beneficial to distinguish in night. In one word, it can increase the efficient, convenient and fast service quality of the hotel, and increase the guest's satisfaction.



PRODUCT FEATURES:

Panel: dazzle colour crystal, crystal clear, never deformation, discoloration, noble fashion design style.
 Frame: zinc alloy metal frame, solid and high-grade.
 Bottom box: adopt ABS fireproof material.
 Color: black stones, crystal white, rose gold, champagne gold, brown and other colors are optional.
 Energy saving: low standby power consumption, energy conservation and environmental protection.
 Function: cable numerical control technology, the unique code technology, single and double way dimmer.
 Touch screen: adopt the most advanced electronic touch technology, manual touch can reach more than 100000 times.

PRODUCT FEATURES:

Used in superior hotel,club,sauna,KTV,tea house and so on. Various modern design styles are optional, showing special glamour. The touch light point indication of the LCD backlight is clear which is beneficial to distinguish in night. In one word, it can increase the efficient, convenient and fast service quality of the hotel, and increase the guest's satisfaction.



SH-LC-F
 size: 120mm×380mm×9mm



PRODUCT FEATURES:

Panel: dazzle colour crystal, crystal clear, never deformation, discoloration, noble fashion design style.
 Frame: zinc alloy metal frame, solid and high-grade.
 Bottom box: adopt ABS fireproof material.
 Color: black stones, crystal white, rose gold, champagne gold, brown and other colors are optional.
 Energy saving: low standby power consumption, energy conservation and environmental protection.
 Function: cable numerical control technology, the unique code technology, single and double way dimmer.
 Touch screen: adopt the most advanced electronic touch technology, manual touch can reach more than 100000 times.



SH-CM8008-4
 Size:344mm×86mm×7mm



SH-CM8008-2
 Size:172mm×86mm×7mm

ULTRA-THIN METAL FRAME



SH-CM8008-3
 Size:258mm×86mm×7mm

PRODUCT FEATURES:

Ultra-thin metal frame, touch switch bezel only iPhone 5s thickness of 7 mm thickness. The zinc alloy electroplating, 72 hours salt spray test standard. Meet the national industry standard.

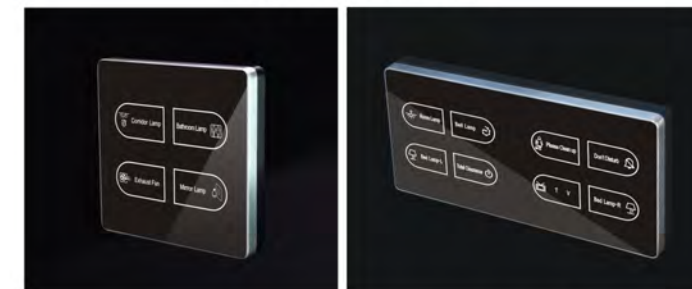

SH-CM8008-1
 Size:86mm×86mm×7mm

SH-CM8008-2
 Size:172mm×86mm×7mm

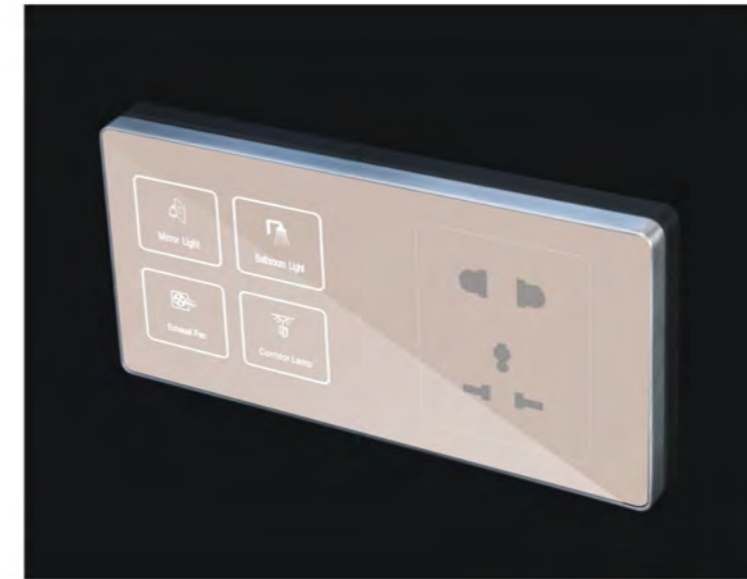

Size:172mm×86mm×7mm

PRODUCT FEATURES:

Suitable for all kinds of installation environment, installation is simple. It can be installed on the wooden surface of the head of a bed.

MAXIMUM SIZE OF THE LED BACKLIGHT

TECHNICAL PARAMETERS

Working voltage:DC5V/12V, AC110/220V.
 Service life: touch screen 100000 times .
 Work consumption: power consumption low power design, standby power consumption: less than 0.2W.
 Applicable environment: suitable for incandescent lamp dimming, maximum power 100W.



Size:344mm×86mm×7mm



Size:258mm×86mm×7mm

THE CHARACTERISTICS OF TOUCH INTELLIGENT SWITCH.

- ◆ With the widely application of the touch smartphones, touch switch has become attract customer's first choice.
- ◆ Ultra-thin metal frame, dazzle colour crystal panel, contemporary feeling strong visual perception, to improve the grade of the hotel.
- ◆ It's easy to identify the light switch from the LCD panel.
- ◆ Without any external equipment matching, only a weak current in parallel coaxial twisted-pair (telephone twisted-pair) can easily implement intelligent lighting control.
- ◆ Installation easy, the hotel's electrician can install.

DIAGRAMMATIC DRAWING FOR HOTEL RUESTROOM WIRING

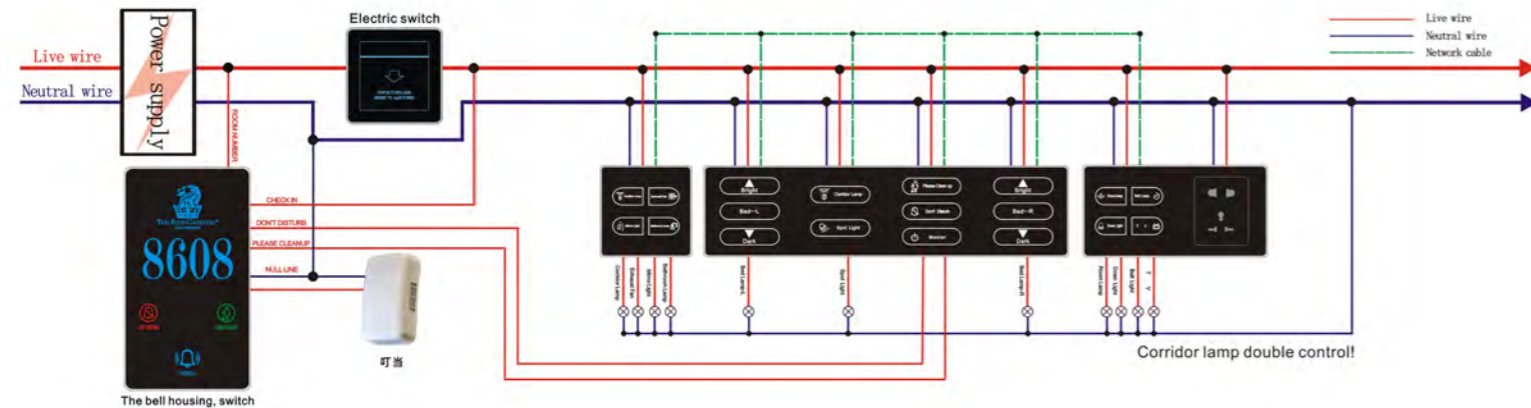

SMART TOUCH SWITCH FUNCTION

Super luxury appearance design manifests luxurious. Various modern design styles are optional, LCD backlight touch switch keys can be control by pressing switch. The light point indication is clear, which is beneficial to distinguish in night and lead the times trend. New type intelligent general switch, universal double control, multi-control. It is suitable for hotel, home, office, meeting room, exhibition hall and so on.

Easy installation: standard type 86 wall switch design, do not need to make any changes in light.

Suitable for lamp: can connect fluorescent lamp, incandescent lamp, energy saving lamp, spotlight, halide torch and others.

One key general switch: the guest can easily turn off all specified lambs by pressing the key without standing up, and turn on the lamps respectively. The humanized design bring careful and comfortable feel to the guests.

Multi-control: the guest can turn on or off the lamps such as room lamp, corridor lamp and toplight by pressing any switch at corridor or beside as his/her pleasure, need not moving.

Intelligent corridor lamp: the corridor will automatically light after insert the card for power, so the guests need not enter into room in darkness.

Intelligent night lights: the night light will automatically turn on if the guest presses the one key general switch when he wants to get up.

Night light display: LCD backlight display, fit for distinguishing in evening.

Personalized custom: the characters and pattern display can be customized to avoiding wrong pressing.

Energy conservation and convenience: the guest does not need to stand or move, he can conveniently control all lamps by the one key general switch. And the hotel can save energy.





PRODUCT FEATURES:

- The panel is made of micro crystal plate, never deformation, multicolor choice.
- High back seat is made of high quality nylon A86 plastic insulation, flame retardant, good mechanical radian, long service life.
- Socket shrapnel using high elasticity tin phosphor bronze strip with excellent fatigue deformation, elastic lasting. To eliminate the phenomenon of because of poor contact plug and fever, to ensure the safe use.
- Steel structure frame, security firm
- Rare earth melting point of silver alloys, effectively remove arc.

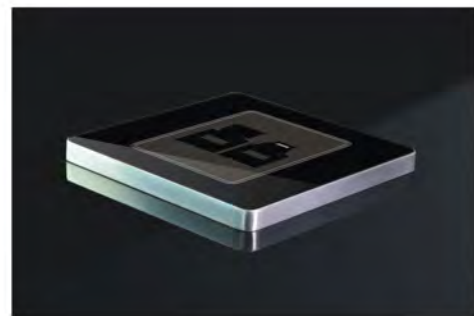

SH-CZ6006
size:86mm×86mm×7mm



SH-CZ6003



SH-CZ6009



SH-CZ6012

FUNCTION INTRODUCTION

Hotel energy saver switch is new type power switch developed on the base of guest room technology. When the hotel guest open the door with room card, and insert the card into hotel energy saver switch, the energy switch will turn on the general power of guest room.

If the guest wants to go out and draw the card in energy switch, the hotel energy saver switch will cut off the general switch in 8 seconds. Therefore, the guest room can be of power if guest is in and no power if guest leaves.

TECHNICAL PARAMETERS

Working voltage: DC5/12V,AC110/220V
 Maximum load power: 5000~8000W
 Relayed power-off time: 10~20 seconds
 Service life: the service life of the relay shall be 40,000 hours in specified loading.
 Working temperature: 10°C~50°C
 Working humidity: 0~80%RH
 Boundary dimension : 86mm×86mm
 Shell material: imported fireproof antflaming PC plastic, crystal glass panel.
 Shell color: high grade porcelain white, formulated silver color and champagne gold color and others colors for optional.
 Extended function: can match with various brands of guest control host.
 Low frequency electric switch suitable for TEMIC, EM and ID card.
 High frequency electric switch suitable for Mifare card.



SH-QD5001
size:86mm×86mm×7mm



SH-QD5002
size:86mm×86mm



DOORBELL SERIES FUNCTION

- Hotel popular standard tone
- Using wired control, 220V ac power supply.
- The appearance of high-grade, slim and beautiful.

TECHNICAL PARAMETERS

Type: chatter doorbell/music doorbell;
 Working voltage: 220V or 12V, 4.5V and 3V;
 Working humidity: 0~90%;
 Working temperature: -10~50 degree;
 Extended function: can match with various brands of guest control host.



SH-DD1001
 size:120mm×38mm×70mm

SH-DD1002
 size:86mm×86mm×7mm



SH-DD1005
 size:88mm×62mm×24mm

